

IP ISENMANN 

ACCESSOIRES & PRODUITS ANTIABRASION

www.isenmann.fr



L'AUTRE MANIÈRE DE MONTER VOS PAVÉS MODULAIRES ISENMANN

WS 2.10



 **ISENMANN** 

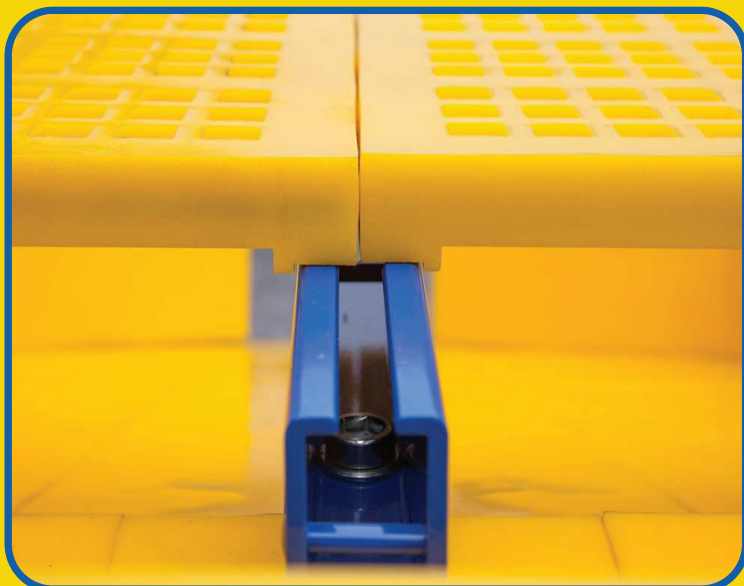
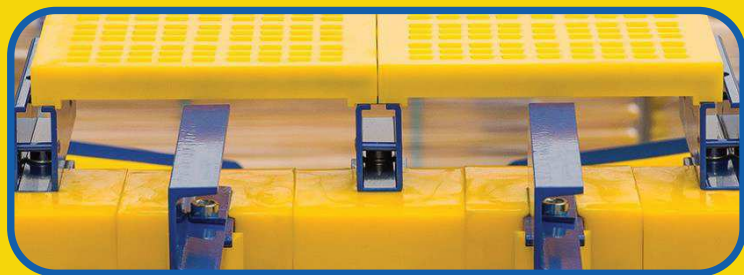

SIMPLICITÉ



SÉCURITÉ



GAIN DE TEMPS

SOMMAIRE

Nos accessoires en polyuréthane ISEPREN

• Buses d'arrosage	04
• Protections de rampes d'arrosage	04
• Plinthes latérales ISEPREN aimantées WS 2.10	05
• Bavettes ISEPREN aimantées WS 2.10	05
• Soufflets ISEPREN	06
• Profils de grille ISEPREN	07
• Racleurs de bandes transporteuses ISEPREN	07
• Guirlandes de décolmatage ISEPREN	07
• Rouleaux anticollmatants et bagues ISEPREN	08
• Protections ISEPREN aimantées WS 2.10	09
• Plinthes de tension et OMEGA	09
• Boulonnerie	09

Nos produits en polyuréthane ISEPREN antiabrasion

• Plaques ISEPREN	10
• Plaques ISEPREN aimantées WS 2.10	10
• LINE-TECH (version boulonnée et aimantée)	11
• Protections ISEPREN aimantées WS 2.10 pour lignes d'arbres ISEPREN	12
• Protections ISEPREN aimantées WS 2.10 pour traverses de grille	12

Nos produits en caoutchouc ISEGUM

• Profils de grille ISEGUM	13
• Rouleaux ISEGUM	13
• Bavettes ISEGUM	13
• Modules ISEGUM 300 x 300 mm	14
• Plaques ISEGUM	14
• Barres d'impact ISEGUM	14

Buses d'arrosage ISEPREN

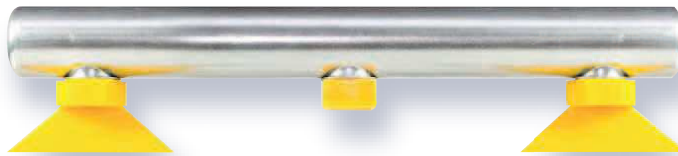
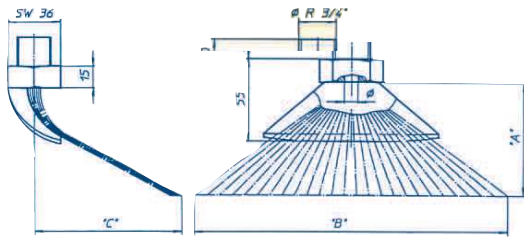

LES BUSES STANDARDS

LES BUSES STANDARDS								LES MINI BUSES	
(bar)		Ø 4	Ø 5	Ø 6	Ø 7	Ø 9	Ø 11,5	Ø 10,0	
	A	B / C	B / C	B / C	B / C	B / C	B / C	B / C	
1		<u>8,8</u>	<u>12,4</u>	<u>18,3</u>	<u>24</u>	<u>40</u>	<u>55</u>	<u>48</u>	l/min
	200	350 / 300	430 / 300	475 / 300	520 / 300	600 / 300	650 / 300	350 / 400	mm
	300	470 / 465	550 / 465	595 / 465	640 / 465	725 / 465	850 / 465	460 / 490	mm
	400	600 / 650	680 / 650	720 / 650	760 / 650	850 / 650	1050 / 650	600 / 650	(mm)
2		<u>12</u>	<u>17,2</u>	<u>26,0</u>	<u>34,8</u>	<u>60</u>	<u>82</u>	<u>72</u>	l/min
	200	400 / 315	490 / 315	535 / 315	580 / 315	670 / 315	700 / 315	450 / 500	mm
	300	530 / 490	630 / 490	685 / 490	740 / 490	840 / 490	900 / 490	580 / 660	mm
	400	670 / 665	780 / 665	835 / 665	890 / 665	1000 / 665	1100 / 665	700 / 720	(mm)
3		<u>15,2</u>	<u>22</u>	<u>45,6</u>	<u>45,6</u>	<u>80</u>	<u>110</u>	<u>90</u>	l/min
	200	450 / 330	500 / 330	595 / 330	640 / 330	740 / 330	770 / 330	550 / 600	mm
	300	600 / 500	720 / 500	775 / 500	830 / 500	950 / 500	1010 / 500	680 / 720	mm
	400	740 / 680	880 / 680	945 / 680	1010 / 680	1150 / 680	1250 / 680	850 / 900	mm
4		<u>18,4</u>	<u>26,8</u>	<u>41,6</u>	<u>56,4</u>	<u>100</u>	<u>137</u>	<u>115</u>	l/min
	200	500 / 350	600 / 350	655 / 350	710 / 350	810 / 350	850 / 350	680 / 770	mm
	300	650 / 525	780 / 525	850 / 525	920 / 525	1050 / 525	1120 / 525	860 / 910	mm
	400	800 / 700	970 / 700	1050 / 700	1130 / 700	1300 / 700	1400 / 700	950 / 980	mm

Mini buse LH

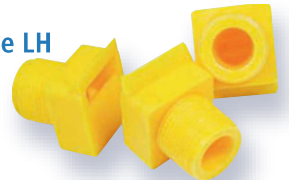

Protections de rampes d'arrosage ISEPREN



Protection optimale contre l'abrasion

Diamètres disponibles	40 x 40 mm	Ø 76,1 mm	Ø 60,3 mm	Ø 48,3 mm	Ø 42,4 mm	Ø 33,7 mm
-----------------------	------------	-----------	-----------	-----------	-----------	-----------





Plinthes latérales ISEPREN aimantées



Pas de boulonnerie, pas de cales



Bavettes ISEPREN aimantées

Disponibles en épaisseur : 25 mm
et hauteur : 200 mm



Pas de boulonnerie



Soufflets ISEPREN

- Avec flasque
 - Composés d'une base cylindrique rigide en polyuréthane

Ø dans la paroi	Ø du tube	Longueur
Ø 135 mm	Ø 42 mm	Ø 160 mm
Ø 146 mm	Ø 42 mm	Ø 160 mm
Ø 150 mm	Ø 42 mm	Ø 160 mm
Ø 150 mm	Ø 48 mm	Ø 160 mm
Ø 170 mm	Ø 42 mm	Ø 170 mm
Ø 170 mm	Ø 48 mm	Ø 170 mm
Ø 170 mm	Ø 60 mm	Ø 170 mm
Ø 180 mm	Ø 76 mm	Ø 180 mm
Ø 400 mm	Ø 179 mm	Ø 146 mm

- Avec colliers de serrage

Ø dans la paroi	Ø du tube	Longueur
Ø 130 mm	Ø 60 mm	112 mm
Ø 136 mm	Ø 45 mm	125 mm
Ø 160 mm	Ø 42 mm	132 mm
Ø 160 mm	Ø 48 mm	132 mm
Ø 160 mm	Ø 60 mm	132 mm
Ø 168 mm	Ø 42 mm	137 mm
Ø 168 mm	Ø 48 mm	137 mm
Ø 168 mm	Ø 60 mm	137 mm
Ø 200 mm	Ø 42 mm	159 mm
Ø 200 mm	Ø 48 mm	159 mm
Ø 200 mm	Ø 60 mm	159 mm
Ø 220 mm	Ø 42 mm	172 mm
Ø 220 mm	Ø 48 mm	172 mm
Ø 220 mm	Ø 60 mm	172 mm

100% POLYURÉTHANE

- Usure minimale
- Haute résistance à l'abrasion
- Pas de dépôt de matériaux

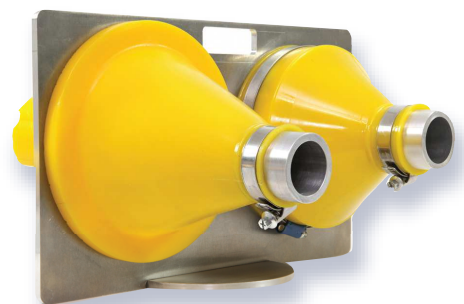

AVANT



APRÈS

Profils de crible ISEPREN

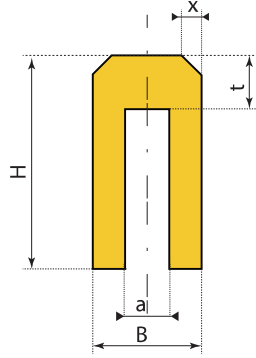
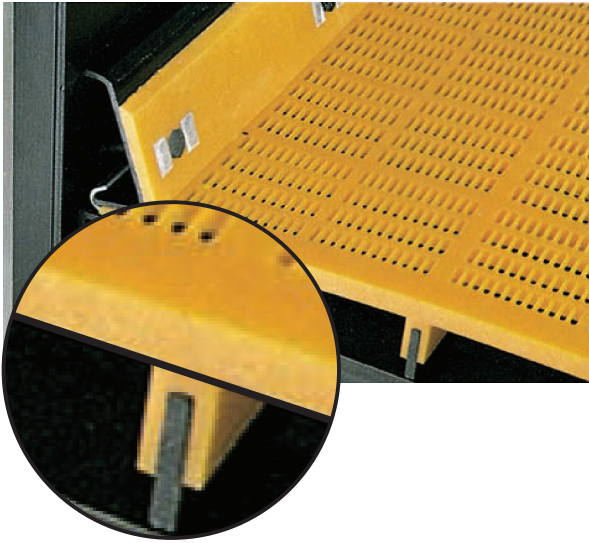

a	t	B	H	x
6/8/10	5	20	30	3 x 45°
	7,5			
	10			
	12,5			
6/8/10	10	20	40	3 x 45°
	15			
	20			
12/15	10	25	40	5 x 45°
	15			
	20			
12/15	10	30	40	5 x 45°
	15			
	20			
12/15	10	35	60	5 x 45°
	15			
	20			

Racleurs de bandes transporteuses ISEPREN

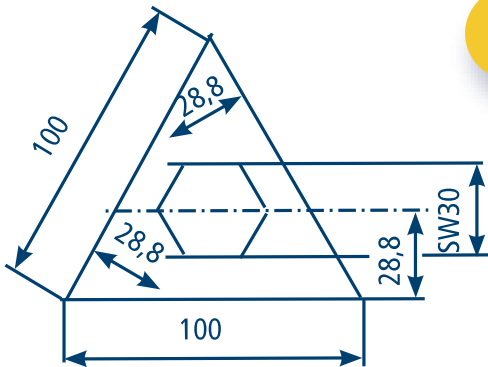

Plan N° SK. 719. 1/85 (3)

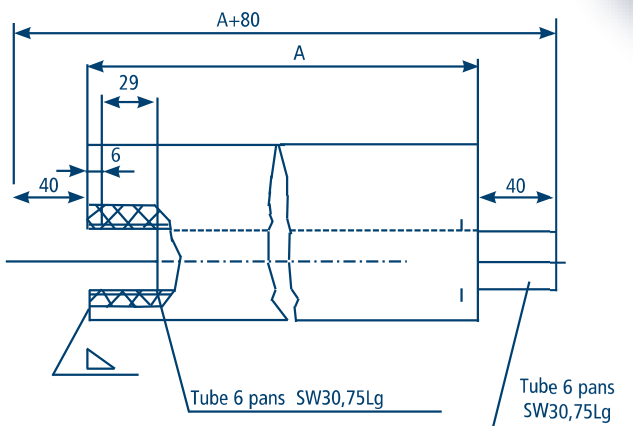

Plan N° SK. 719. 1/85 (3)



A en mm	Poids Total
200	2,0 Kg
250	2,4 Kg
300	2,7 Kg
350	3,0 Kg
400	3,3 Kg
450	3,6 Kg
500	3,8 Kg
600	4,4 Kg
650	4,6 Kg
700	4,9 Kg
750	5,2 Kg
800	5,5 Kg
850	5,9 Kg
900	6,1 Kg
950	6,4 Kg
1000	6,7 Kg
1050	7,1 Kg
1100	7,4 Kg
1150	7,7 Kg
1200	8,1 Kg
1300	8,7 Kg
1400	9,3 Kg

Guirlandes de décolmatage ISEPREN

Boules polyuréthane \varnothing 30 x 40 mm
entraxes : 150 mm reliées par un câble d'acier
revêtu de polyuréthane antiabrasion \varnothing 6mm



Rouleaux anticolmatants et bagues ISEPREN

Nos rouleaux sont disponibles avec ou sans bagues extérieures de centrage en diamètre 63,5 ou 89 mm

- Dimensions sans bagues de centrage :
 - \varnothing 63,5 x 2,9 x 108 mm.
 - \varnothing 89,0 x 2,9 x 133 mm

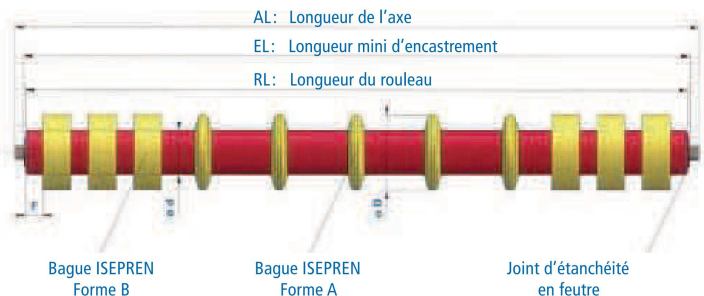

- Dimensions avec bagues de centrage :
 - \varnothing 63,5 x 2,9 x 244 mm.
 - \varnothing 89,0 x 2,9 x 269 mm

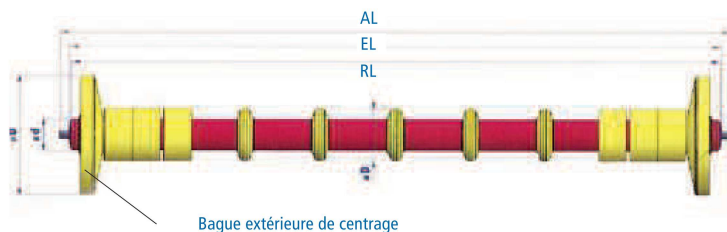

Longueurs disponibles : (\varnothing 63,5 et 89 mm)

Largeur de bande	Longueur
500 mm	600 mm
650 mm	750 mm
800 mm	950 mm
1000 mm	1150 mm
1200 mm	1400 mm

Accessoires pour rouleaux

Bague de forme A

D	d	b
\varnothing 108 mm	\varnothing 63,5 mm	25
\varnothing 120 mm	\varnothing 63,5 mm	30
\varnothing 133 mm	\varnothing 89,0 mm	30
\varnothing 159 mm	\varnothing 89,0 mm	30

Bague de forme B

D	d	b
\varnothing 108 mm	\varnothing 63,5 mm	40
\varnothing 120 mm	\varnothing 63,5 mm	40
\varnothing 133 mm	\varnothing 89,0 mm	40
\varnothing 159 mm	\varnothing 89,0 mm	40

Bague extérieure de centrage

D	d	b
\varnothing 244 mm	\varnothing 63,5 mm	35
\varnothing 269 mm	\varnothing 89,0 mm	35

Circlips

d
\varnothing 63,5 mm
\varnothing 89,0 mm

Bague extérieure de centrage

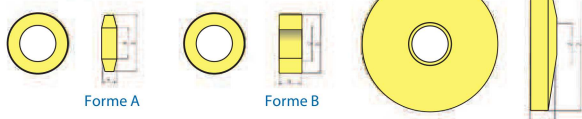

ISETURN

Retournement de bande

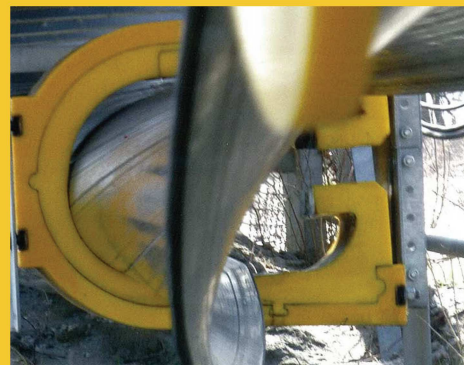
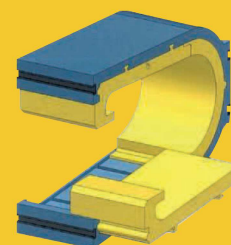

Protections ISEPREN aimantées pour plinthe de tension



Plinthes de tension en acier S235JR *(perçées suivant plan)*

Disponibles :

- Sans revêtement polyuréthane en épaisseur 6 ou 8 mm
- Avec revêtement polyuréthane en épaisseur 6 + 8 mm de PU

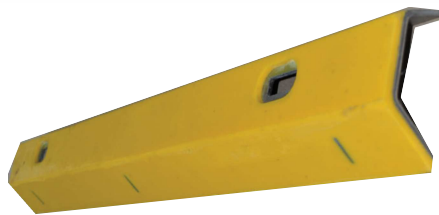

Plinthes de tension centrale «OMEGA» *(perçées suivant plan)*

«OMEGA» en acier S235JR

Disponibles en épaisseur 8 mm



Boulonnerie

TRCC

- M16 x 140/ 80 mm
- M18 x 120/100 mm
- M18 x 140/ 90 mm
- M20 x 120/ 90 mm



TMCC

- M16 x 120/100 mm
- M16 x 160/135 mm
- M18 x 140/120 mm
- M18 x 160/135 mm



Boulons zingués-bichromatés, conditionnés par 50 unités avec écrous et rondelles

Boulonnerie spéciale (vendue à l'unité)

- Rondelle cuvette ép. 10,0 mm, \varnothing 50/22 mm
- Rondelle plate ép. 6,0 mm, \varnothing 70/30 mm
- Écrou 6 pans \varnothing 18mm, longueur 50 mm
- Écrou 6 pans \varnothing 16mm, longueur 50 mm



- Etrier de fixation \varnothing 12mm, longueur 185 mm
- Double plot ISEPREN

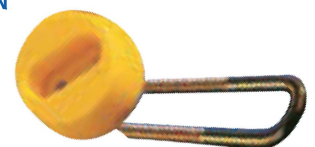

Plaques antiabrasion ISEPREN

- Sans support tôle acier

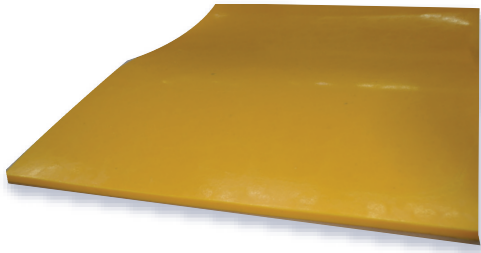

Épaisseurs disponibles

Sans tôle acier	Avec tôle acier
5 mm	/
10 mm	/
15 mm	15 + 3 mm
20 mm	20 + 3 mm
25 mm	25 + 3 mm
30 mm	30 + 3 mm

- Avec support tôle acier

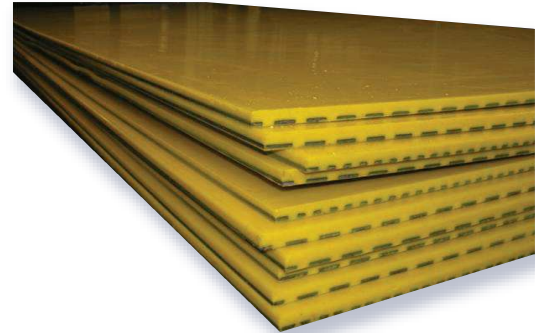

TOUTES DIMENSIONS RÉALISABLES
SUR DEMANDE
AVEC OU SANS PERÇAGE.



Plaques antiabrasion ISEPREN aimantées ^{US 2:10}



LINE-TECH • Modules ISEPREN 300x300 mm pour le garnissage de goulotte

LINE-TECH disponibles en épaisseur 30 ou 40 mm



Conditionnement par caisse

- 33 Modules
- 66 Modules

• Version boulonnée

(avec écrous, rondelles et capuchons protège-écrous)

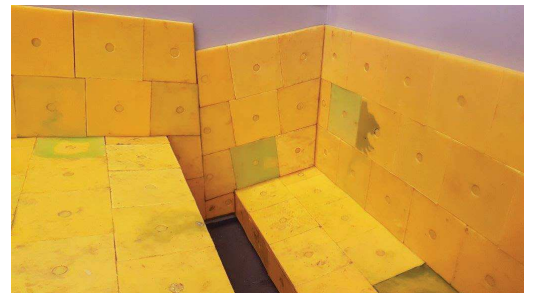

• Version aimantée 2.10

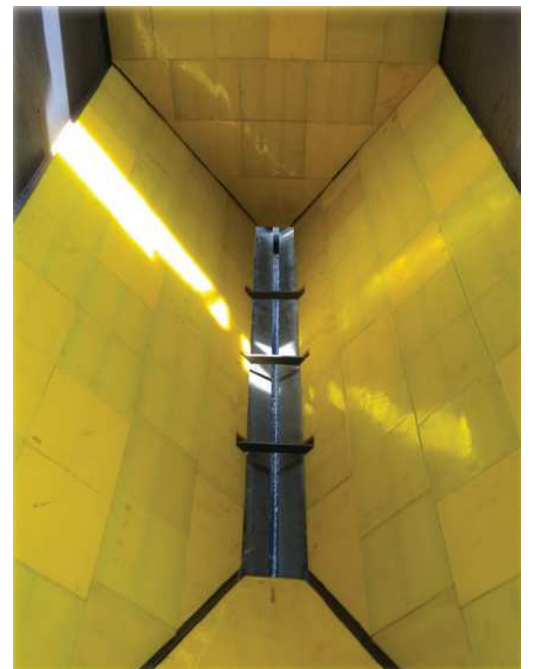
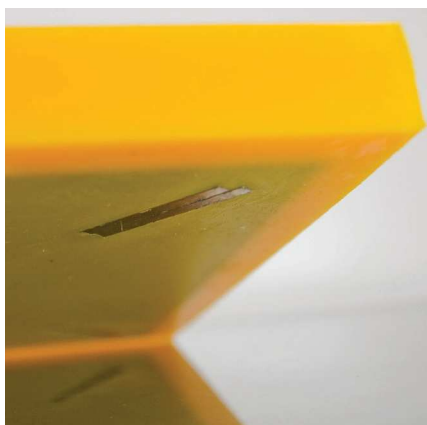
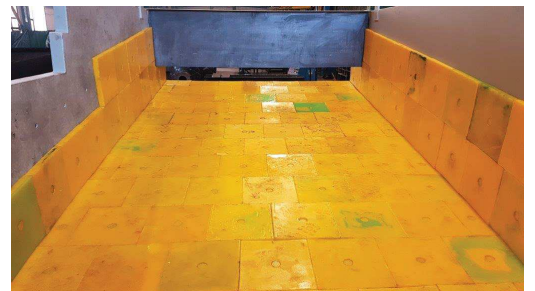

Protections ISEPREN aimantées pour lignes d'arbres



Adaptables à tous types de diamètre



Protections ISEPREN aimantées pour traverses de crible



Compatibles pour tous types de traverse



SIMPLICITÉ, SÉCURITÉ ET GAIN DE TEMPS



WS 2.10

Profils de crible ISEGUM

Conditionné en rouleau de 50m

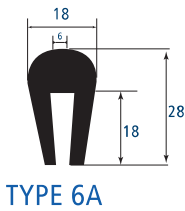

TYPE 6A

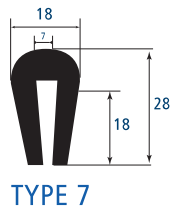

TYPE 7

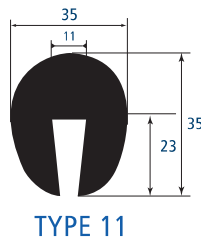

TYPE 11

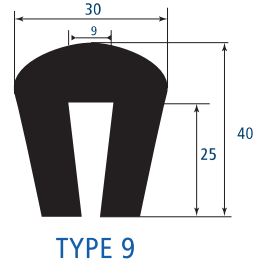

TYPE 9

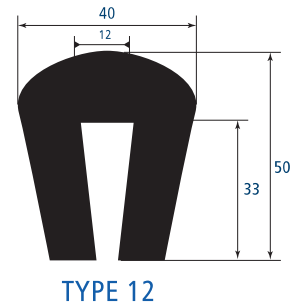

TYPE 12

Rouleaux ISEGUM

en 60 Shore (noir)

Dimension des rouleaux au choix :
5, 10 ou 20m x 1500 mm (-/-30mm)

Épaisseur en mm	6	8	10	15	20	25
-----------------	---	---	----	----	----	----

en 45 Shore (rouge)

Dimension des rouleaux au choix :
10m x 1500 mm (-/-30mm)

Épaisseur en mm	6	8	10	12	15	20	25	30
-----------------	---	---	----	----	----	----	----	----

Bavettes ISEGUM

Dimension des rouleaux au choix : longueur 20 mètres (-/-30mm)

Largeur en mm	100	125	150	200	250	300
---------------	-----	-----	-----	-----	-----	-----

Épaisseur en mm	6	8	10	12	15	20
-----------------	---	---	----	----	----	----

Disponibles en

- 40,45 et 50 Shore (épaisseur 6 à 20 mm)
- 60 Shore (épaisseur 6 à 30 mm)



Modules ISEGUM 300x300 mm

• Modules «Lisses»

60 Shore - vulcanisé à chaud sur tôle acier

Epaisseur en mm 30 35 40 50 55

Possibilité de montage :

- Par boulonnage
- Par goujonnage

Perçage :

- Diamètre 14mm
- Lamé 40mm

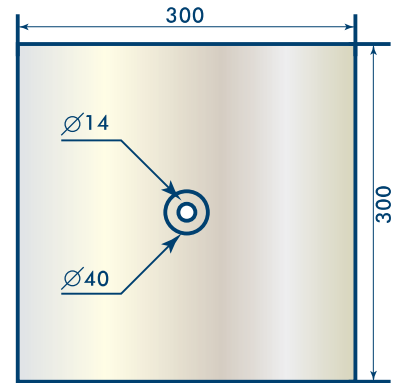

• Modules «Dentés»

Epaisseur en mm 55 80

Possibilité de montage :

- Par boulonnage
- Par goujonnage

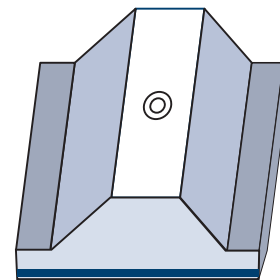
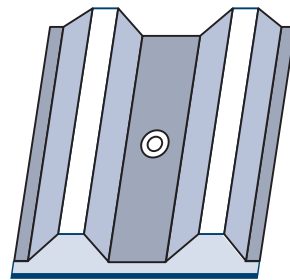

Perçage :

- Diamètre 14 mm
- Lamé 40 mm

Plaques ISEGUM

60 Shore
vulcanisées à chaud sur tôle acier

Epaisseur en mm	
7 + 3	30 + 5
10 + 3	40 + 5
15 + 3	50 + 5
20 + 3	75 + 5
20 + 5	95 + 5
25 + 5	120 + 5

Barres d'impact et de glissement ISEGUM

Type 1

Longueur en mm	
1220 mm	1500 mm
Largeur x Hauteur	
75 x 50 mm	
75 x 75 mm	
75 x 100 mm	
100 x 50 mm	
100 x 75 mm	
100 x 100 mm	

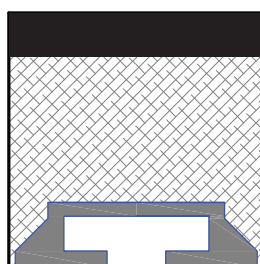

Type 1

Type 2

Longueur en mm	
1220 mm	1500 mm
Largeur x Hauteur	
50 x 50 mm	
50 x 75 mm	
75 x 50 mm	
75 x 75 mm	
75 x 100 mm	
100 x 50 mm	
100 x 75 mm	
100 x 100 mm	

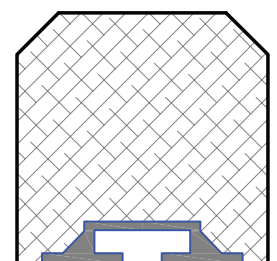

Type 2



BOULONS : TM 16/75 / TM 20/100

Quartier d'entreprises «Le Fortin»
13 rue Desaix • B.P. 91083 • 67452 Mundolsheim Cedex
Tél. 03 88 83 65 57 • Fax : 03 88 33 29 48
E-mail : info@isenmann.fr • www.isenmann.fr



BELGIQUE ET LUXEMBOURG

Frédéric SARTO HYDROTECH Sprl

Mobile : +32 (0)49 53 02 747

Tél. : +32(0)71 78 67 00

Fax : +32 (0)71 78 56 00

fsarto@hydrotech.be



Joseph VIEL

Mobile : +33 (0)6 17 31 26 33

Fax : +33 (0)3 88 33 29 48

joseph.viel@isenmann.fr



Stéphane PLATZ

Mobile : +33 (0)6 29 21 16 00

Fax : +33 (0)3 88 33 29 48

stephane.platz@isenmann.fr

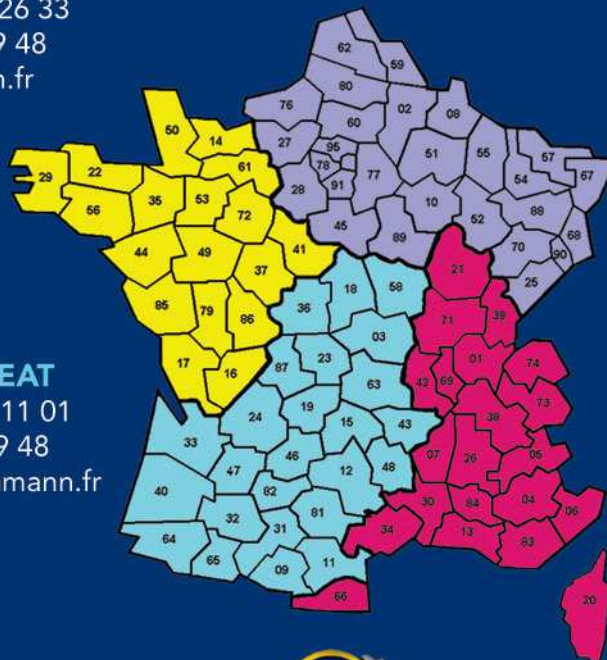

Jean-Claude MORGEAT

Mobile : +33 (0)6 03 63 11 01

Fax : +33 (0)3 88 33 29 48

jean-claude.morgeat@isenmann.fr



Hervé TANGARI

Mobile : +33 (0)6 09 39 41 34

Fax : +33 (0)3 88 33 29 48

herve.tangari@isenmann.fr



EXPORT

Manuel FERNANDEZ

Mobile : +33 (0)6 30 52 47 94

Tél. : +33 (0)3 88 83 88 13

Fax : +33 (0)3 88 33 29 48

manuel.fernandez@isenmann.fr

Retrouvez toute notre gamme de produits sur notre site isenmann.fr